

HORNET™ G2

HIGH PRESSURE CLEANER RANGE

PSI
3000 - 4060

L/PM
11 - 21

OUTPUT
COLD WATER

ENGINE TYPE
1 CYLINDER PETROL OR DIESEL

DRIVE
GEARBOX 1450RPM



G2 MORE FEATURES.
MORE INNOVATION.
MORE TECHNOLOGY.



JETWAVE
POWERED by
HONDA

KOHLER Diesel

A DECISIVE STEP INTO THE FUTURE PACKED WITH INNOVATION.



JETWAVE ABOUT US VIDEO

HORNET™ G2

The Jetwave® Hornet™ G2 range revolutionises the single cylinder petrol and diesel gearbox driven high pressure water cleaner. Australian engineered and assembled with innovative features; it provides the heavy duty user with a powerful, safe and easy to use unit that encompasses smart design. This is the NEW Hornet™ G2 family from Jetwave®.

HERO INNOVATIONS



Stainless Steel Exoskeleton (PEXO™)



Smart customisable modular build.



Centralised control for safety and effectiveness



Anti-vibration Protection System (AVPS™)



JW Premium Italian pumps.



J5000™ DUROTECH™ Gun with swivel and ceramic ball

MAIN FEATURES

Genuine HONDA™ or KOHLER™ engines

Jetwave Safety System (JSS™)

Slow pump running speed

15m double steel braided hose

Zero unloader valve

Professional accessories

Emergency Stop

FIELDS OF APPLICATION

Mining Industry

Civil Construction

Cleaning Contractors

Construction Tradesmen

Government and Councils

Facilities Management

Roofing Contractors

Hire & Rental

HORNET™ G2 JNR



PETROL
3150 PSI • 11 L/PM

HORNET™ G2



PETROL
3000 PSI • 21 L/PM
4060 PSI • 15 L/PM

HORNET™ G2D



DIESEL
3150PSI • 15 L/PM
4060 PSI • 13 L/PM

CLEANING CONTRACTORS



AGRICULTURAL EQUIPMENT

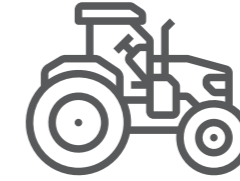

HIRE & RENTAL



MARINE MANAGEMENT



INFRASTRUCTURE CLEANING



MINING INDUSTRY



CIVIL CONSTRUCTION

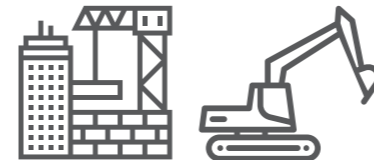

FACILITIES MANAGEMENT



GOVERNMENT AND COUNCIL

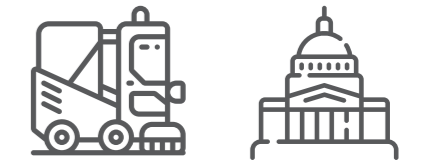



Residential

Industrial

Commercial

Municipal



Homeowners will see investment with your professional specialised machinery. Add a specialist service and contribute to your businesses improved charge out rates.



Heavy industry can produce some heavy cleaning requirements. You need the most powerful, effective and efficient equipment to provide scope for your cleaning.



From the local bakery to the largest commercial office buildings, the Hornet G2 range gets the job done powerfully so you can win more jobs and get back to more business.



We aim to provide you more versatility to tender and win jobs with cost effective investment into equipment and available options.

HORNET™ G2

A decisive step into the future of pressure washing equipment with a product categorically developed for a commercial cleaning professional.

The Hornet G2 dramatically improves and revolutionises the most significant aspects of a single cylinder gearbox driven petrol or diesel pressure washing unit, and the overall experience for its category.

It introduces innovative never seen before bespoke precision CNC design and capability on a high pressure washer. The best performance, technology integration and life protection ever in such machinery. A range of endless mounting possibilities.

A Formed Stainless Steel Exoskeleton cover provides protection from the elements for the life of your investment and functional centralised control with enhanced heavy duty JW Italian pump. It looks every bit as powerfully cutting edge as it is.

This is the Hornet™ G2.

LEARN MORE



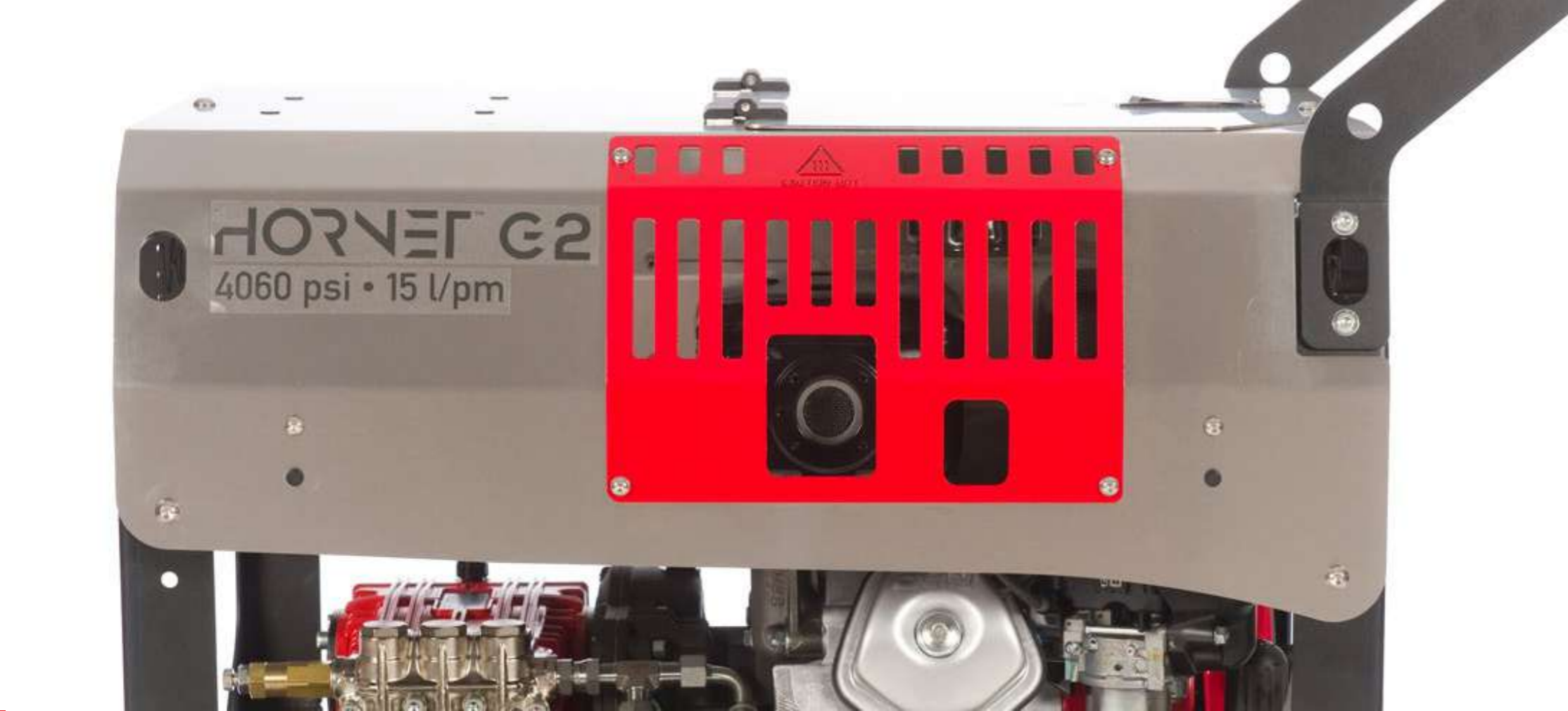

HERO INNOVATION

STAINLESS STEEL

EXOSKELETON

HERO INNOVATIONS



STAINLESS STEEL EXOSKELETON (PEXO™)



STAINLESS STEEL EXOSKELETON VIDEO

PROTECTION & SAFETY

The industrial precision CNC formed Stainless Steel cover provides enduring weather protection to the entire machine and importantly its critical working components protecting it from harsh outdoor weather elements and on site overspray.

BENEFITS

- 01 Compact space saving design.
- 02 Unit and operator safety maximised.
- 03 Made of heavy duty formed stainless steel.
- 04 New attractive and aesthetic design.
- 05 All critical components are still reachable for maintenance / minor repair operation.
- 06 Longer working life of your investment.
- 07 Increases reliability.
- 08 Mitigates risk of down time.
- 09 Easy removable cover for serviceability and maintenance checks.
- 10 Extend maintenance intervals.
- 11 Increased worksite safety.

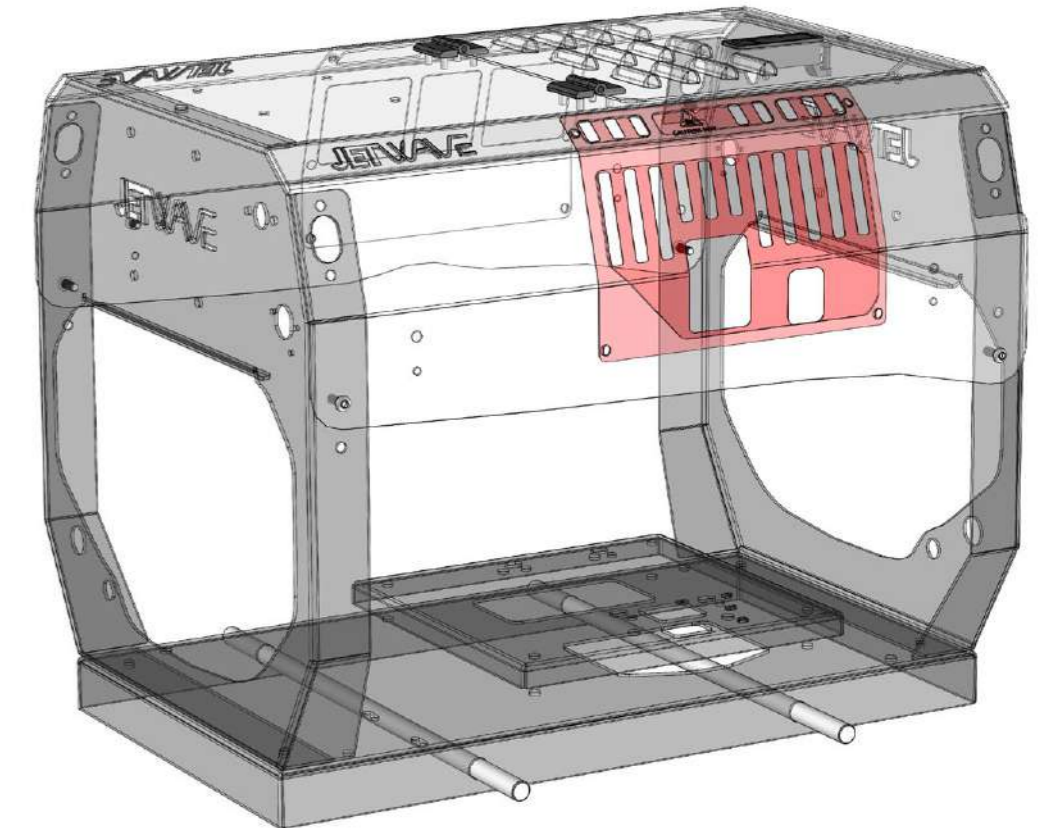

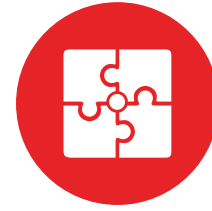

MULTI CONFIGURATION



MULTI CONFIGURATION VIDEO

CUSTOMISABLE & INTUITIVE

New versatility suitable for almost any mounting arrangement you can imagine due to its industry leading compact modular design and configuration options.

Because the Hornet G2 takes up less space it allows you to carry more gear and equipment so you're ready for anything.

BENEFITS

- 01 Spec the unit your exact way in the fleet.
- 02 Get your optimal machine set-up the way you want it.
- 03 Increase your space and productivity by optimal vehicle layout.
- 04 Extended versatility of the equipment in the fleet in case of any vehicle changes / upgrades.
- 05 Maximise vehicle storage space.
- 06 No ad-hoc unit fabrication.
- 07 Kit optionals available.
- 08 Multiple hose reel configurations.
- 09 More portable and uses less space in vehicle or jobsite.

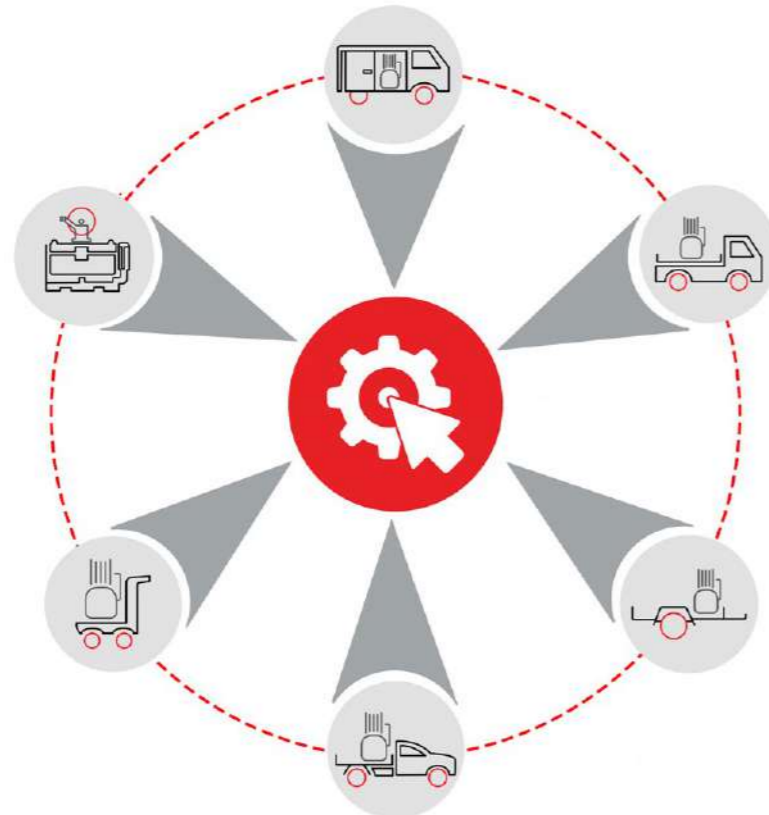

15%
LESS CUBIC SPACE
THAN THE COMPETITION



CENTRALISED CONTROL



CENTRALISED CONTROL VIDEO

FUNCTIONAL & EFFECTIVE

Easily accessible front facing and panel mounted controls in order to maximise effectiveness, operator friendliness and mounting configuration.

BENEFITS

- 01 By having all control points accessible from one side it allows the user to quickly adjust pressure or stop the machine completely in an emergency.
- 02 Provides ease of plug & play connections for any mounting arrangements.
- 03 Having all components panel mounted reduces the risk of key components breaking, decreasing service costs and increasing reliability.

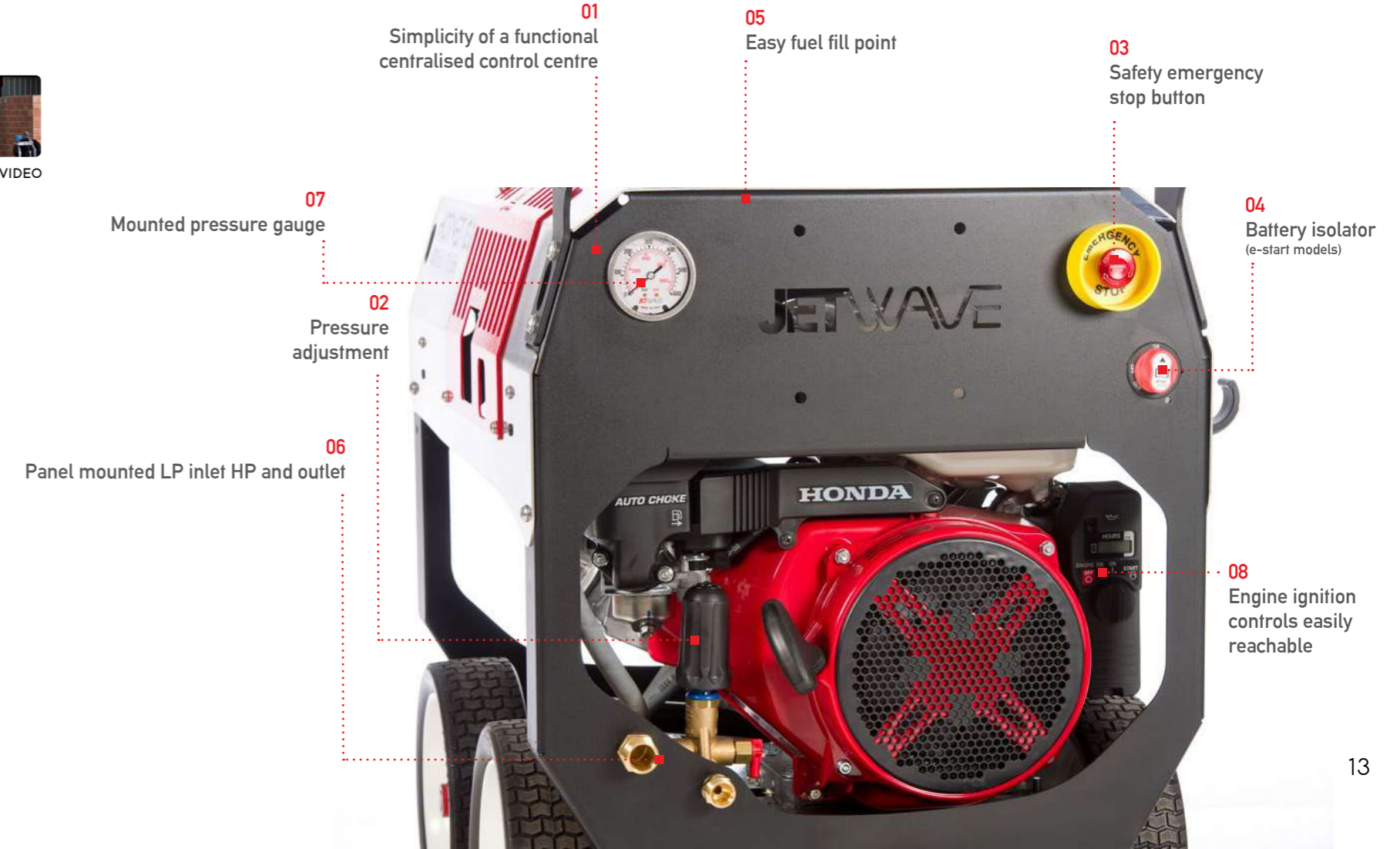



ANTI-VIBRATION PROTECTION SYSTEM (AVPS™)



AVPS PROTECTION SYSTEM VIDEO

QUIETER & LONGER LIFE

The AVPS™ (Anti-Vibration Protection System) contributes to a quieter performance. It has a heavy duty steel motor plate to separate vibration frequency created from the power plant via high duro rubber and enforced steel dampeners.

BENEFITS

- 01 Contributes to quieter smooth operation.
- 02 Longer trouble free life.
- 03 Rust resistant galvanised steel independent motor plate.
- 04 4 x anti-vibration motor plate mounts.
- 05 Protection from overall frame distortion /weld cracking or damage.



Motor mount plate

Anti-vibration damper



PERFORMANCE ANTI-FLAT ALL-TERRAIN WHEELS



ANTI FLAT WHEELS VIDEO

PORTABLE & RELIABLE

The specifically developed, globally sourced oversize anti-flat all-terrain wheels makes for better reliability when moving your equipment across the job site every time.

BENEFITS

- 01 Allows the unit to be mobile on any surface
- 02 No flat tyres

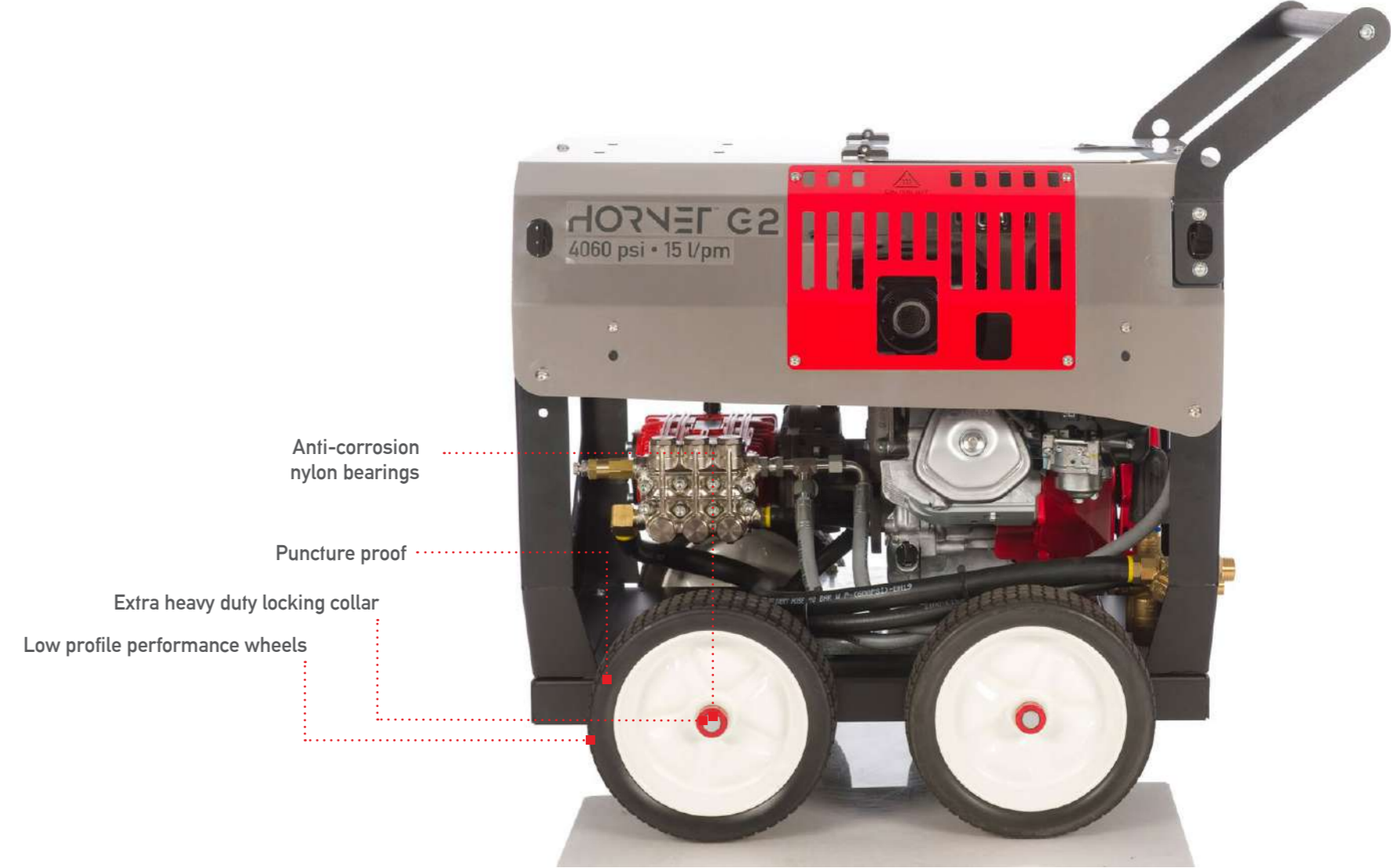

Anti-corrosion nylon bearings

Puncture proof

Extra heavy duty locking collar

Low profile performance wheels

HERO INNOVATIONS

ONLY WITH iGX PETROL MODEL



AUTO-SPEED TECHNOLOGY (AST™)



AUTO SPEED TECH VIDEO

LOWERS SOUND LEVELS

Auto-speed technology, a Jetwave exclusive, provides a link from pump to engine, in effect when jetting is not taking place the engine will decrease to idle RPM speed and back up to optimal RPM full speed to achieve working pressure and flow for the Jetting process. Allowing you to get more out of your equipment putting it to work for longer ultimately effecting positively your bottom line.

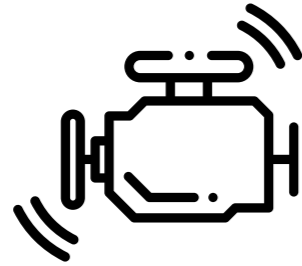

BENEFITS

- 01 Optimises engine speeds to load.
- 02 Significantly extended run times.
- 03 Decreases fuel consumption.
- 04 Drastically decreased noise levels.
- 05 Less RPMs equals less maintenance costs.
- 06 Reduces emissions and exhaust gases.
- 07 Allows you to work day and night.
- 08 Fewer refueling trips.
- 09 Deliver maximum runtime.
- 10 Increase bypass time.

NON-OPERATIONAL SPEED



PERFORMANCE SPEED



HERO INNOVATIONS



PSI BOOST SYSTEM



PSI BOOST VIDEO

FUNCTIONAL & EFFECTIVE

By removing the in-line chemical injector we are able to enhance real cleaning performance when desired.

BENEFITS

- 01 Bypass of chemical venturi system.
- 02 Enhance real cleaning performance.
- 03 Reduce pressure loss overall and over longer hose lengths.
- 04 Deliver greater PSI impact at the nozzle.



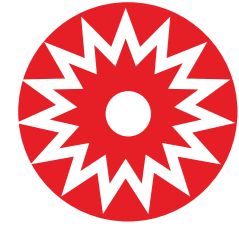

J5000™ DUROTECH™ TECH GUN



PERFORMANCE & DURABLE

J5000 Durotech Gun has the highest performance and durability of its category. Ergonomically designed to grant maximum comfort and safety. Its technical features are max performance at 5075 psi /45 lpm/160°C.

BENEFITS

- 01 Ceramic ball For long life due to the high resistance of hard water, chemicals and chlorine exposure.
- 02 Comfortable LFAHT System (Low Force Activation / Holding Trigger) requires minimum force to hold and activate.
- 03 Live anti-kink in built swivel connector for the high pressure hose inlet.
- 04 Thermal insulation of the gun for operator protection.

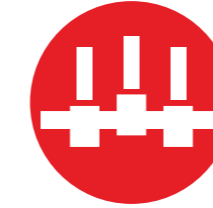
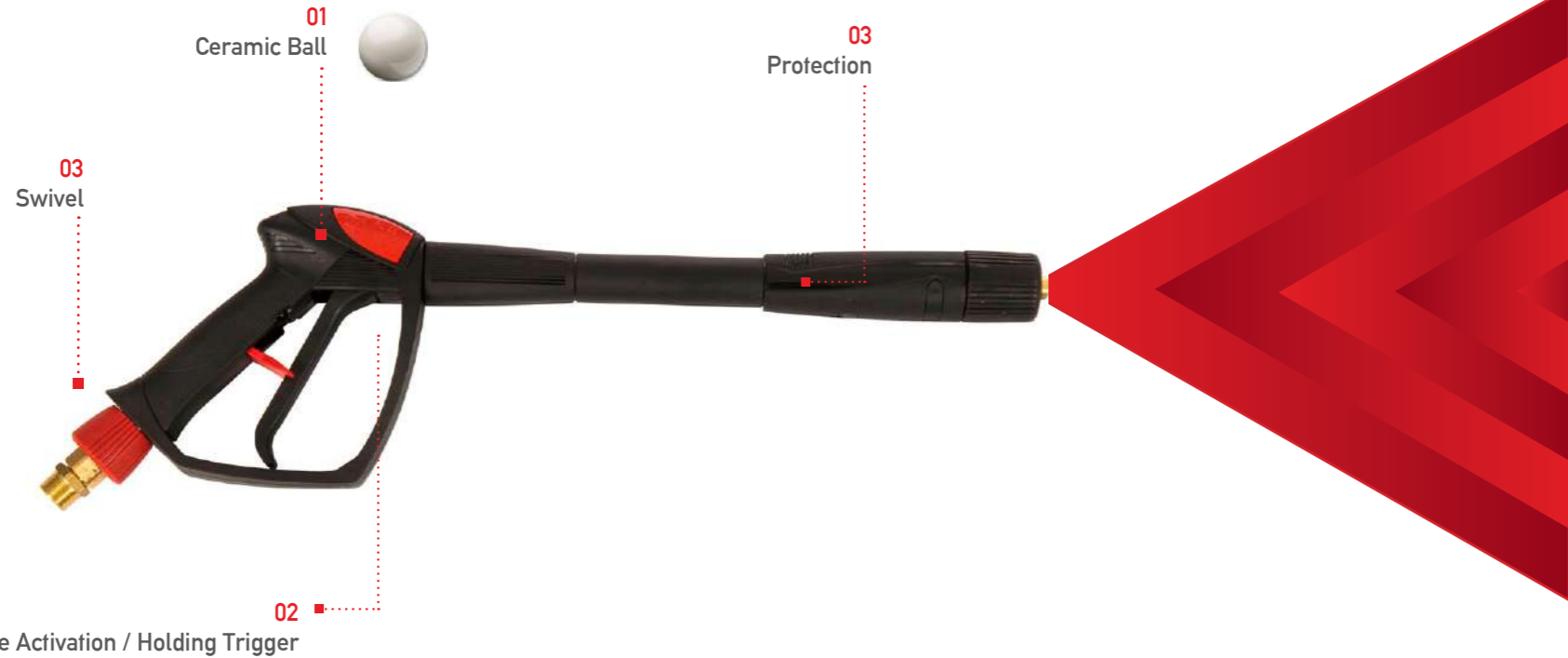

JW PREMIUM PUMPS

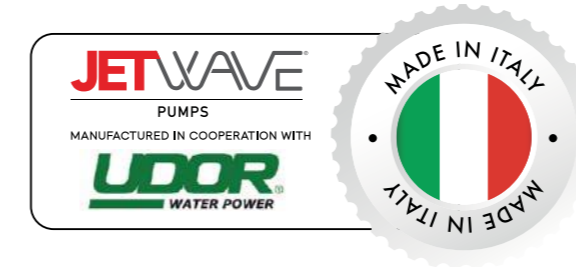

LOW MAINTENANCE & HIGH EFFICIENCY

The finest quality Italian raw materials are used in the newly developed JW Premium Pump range, it redefines the bench mark of quality. Designed in close cooperation with the ISO9001 research & development department of one of the worlds largest plunger pump manufacturers, this pump series is packed with exclusive innovative solutions to improve pump performance, reliability and longer life.

This new premium pump range guarantees the highest levels of reliability on the market even in the harshest of working conditions.

BENEFITS

- 01 Overall enhanced efficiency and aesthetic performance pump design.
- 02 Oversized rear crankcase to reduce oil temperatures and to run cooler for longer.
- 03 Nickel treated brass forged manifold for anti-corrosion, and better resistance to fatigue
- 04 Magnetic oil drain plug to attract all microscopic material.
- 05 Red powder coated die cast aluminum crank case. Resulting in MORE Corrosion resistance.
- 06 Unique blended NBR seals for a longer life in heavy duty application.
- 07 Dust cover for seal protection in dirty environment.
- 08 Glass fibre impregnated valve cages for higher temperature resistance
- 09 Oversized Plunger guide with 'step' diameter for longer seal life.
- 10 Large, easily visible oil level sight glass.
- 11 Two piece Conrods in low friction alloy to improve load distribution.
- 12 Premium quality bearings, for lower friction to ensure lower operating temperatures.
- 13 Teflon based gasket on rear cover to ensure better sealing at high oil temperature.
- 14 Extra thick solid ceramic pistons for greater durability to wear & thermal shock.
- 15 Stainless steel high volumetric efficiency inlet & delivery valves for greater cleaning performance

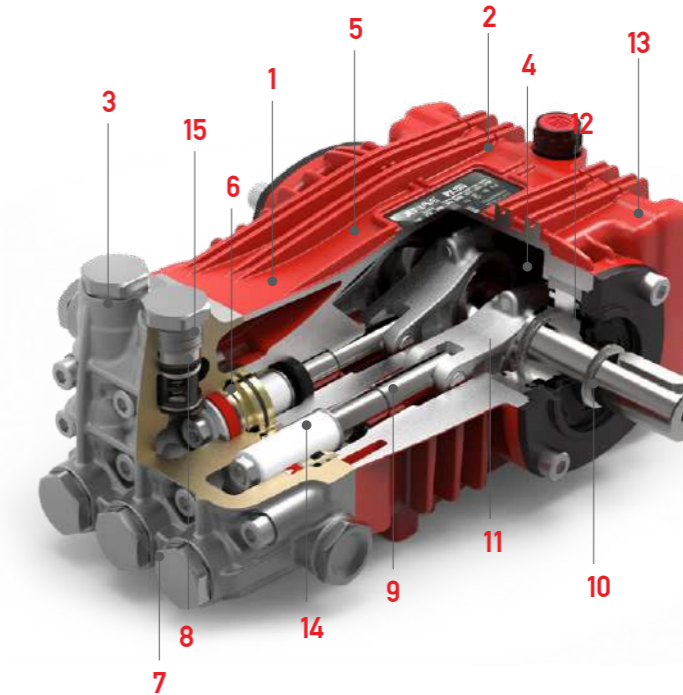



STANDOUT FEATURES



World class industrial HONDA™ and KOHLER™ engines



Dual M22 screw hose coupling system



Triplex professional Italian pump delivers performance and longer life



Zero brass adjustable unloader valve.



Easy electric key start with maintenance free battery



PUMP, GEARBOX AND COMPONENTS

The highest quality precision Italian manufactured components with enhanced flow and pressure performance.

FRAME STRUCTURE

Modular and compact precision CNC design incorporating provision for mounting kits and multiple hose reel mounts.

STAINLESS STEEL EXOSKELETON/COVER PROTECTION (PEXO™)

Sturdy industrial formed cover protection for durability and enduring component protection for the life of your investment

HIGH / LOW PRESSURE OUTLETS

External panel mounted for plug+play connection for multi-configuration and more reliability.

ANTI-VIBRATION SYSTEM (AVPS™)

Exclusive to Jetwave this boasts life expectancy and ensures a longer, quieter unit performance.



15m of 3/8" double steel armoured non-marking hose



Jetwave Safety System™(JSS) thermal valve to prevent overheating in excessive bypass and over pressurisation



Professional accessories with integrated storage for gun and lance



Low speed professional pump for increased reliability and longer maintenance intervals



Emergency stop protection

STANDOUT FEATURES

TIE DOWN POINTS

Easily secure load in transportation.

ZERO UNLOADER VALVE

Zero brass adjustable unloader valve.

HEAVY DUTY

Washable in-line gauze water filter.

ADJUSTABLE PRESSURE

Fascia mounted unloader valve for flexible cleaning.

SAFETY VALVE

Compliant and set valve to prevent pressure spikes and damage to the pump.

OPTIONAL 30M OR 60M CAPACITY HOSE REEL

NEW High quality heavy duty reel built to last, in-built drag break and multi-point locking pin.

OPTIONAL WATER TANK

High quality sturdy and large capacity with a high flow float valve system.

OPTIONAL TOP LIFT

Centre balanced top lifting facility for job site and ease of mobility.



PAYBACKS IN INNOVATION YOU CAN TAKE TO THE BANK

Operator safety and functionality greater than ever before.

Reduce expenses and downtime.

Choice of petrol with performances of 3000 - 4060 psi at 11-21 lpm in petrol/ diesel driven performance.

Improve productivity and job site safety.

Increase runtime.

Optimise space via configurations, meaning more room in your van, truck or work trailer for other job site tools and equipment.

Decreased risk of operator error. Maintenance costs squeezed.

Lower cost of ownership long term.

Product longevity.

Investment protected.

Jobs done faster, safer and more efficient.

Versatility across mounting/vehicle configurations to provide space savings.

Centralised integrated performance data and adjustment.



Seamlessly mount your way.

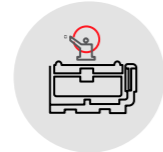

SKID MOUNT

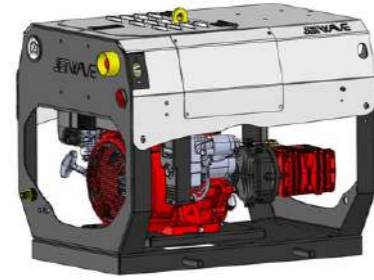

1.0 Skid



TROLLEY MOUNT



2.0 Trolley - Standard

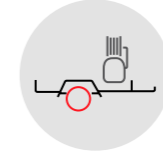

TRAILER MOUNTS

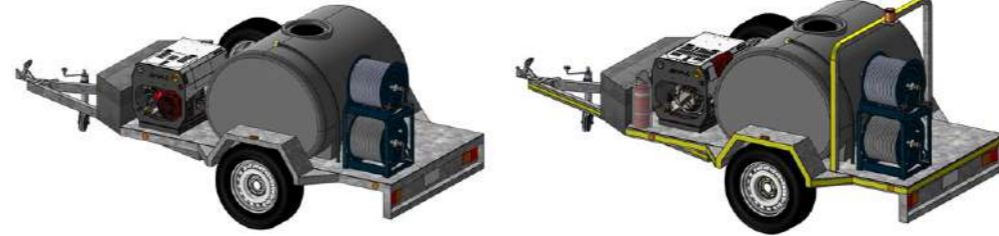

3.1 Trailers - Single Axle 1000L
(Hornet G2D Shown with Mine Spec Upgrade)

3.2 Lite Trailers - Single Axle 200L



2.2 Trolley - Top Hose Reel

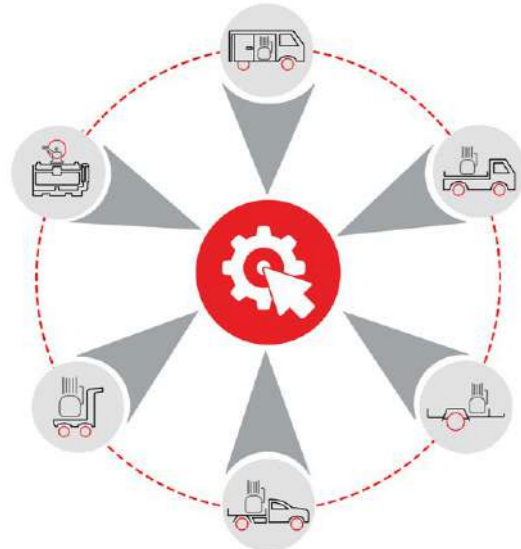

Units are shown with optional hose reel.



UTE MOUNT

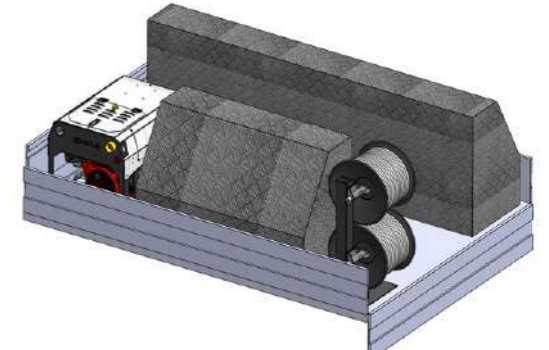

4.1 Ute - Setup 1

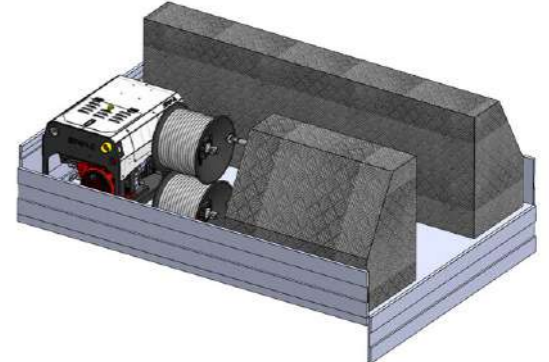

4.2 Ute - Setup 2

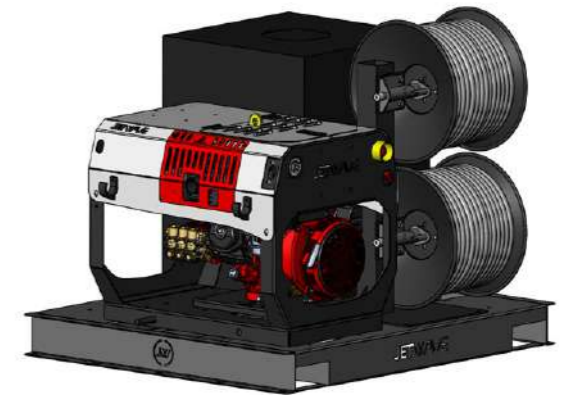

4.3 Skid Pack with 200L Tank for Van/Truck/Ute/Trailer Mounting



J5000 DUROTECH GUN



Ergonomic J5000™ Durotech™ Gun heavy duty spray gun with back part lance and centre quick coupling.

TWIN LANCE



Twin Lance with variable pressure adjustment with stainless steel hardened nozzle.

DWB HOSE



15m of 3/8" double wire braided hose with quick coupling.

4 WHEEL TROLLEY KIT



Puncture proof tyres trolley kit for machine mobility.

ENGINE HOUR METER



For optimal service tracking.

P/N: TOL8075 (Petrol)
P/N: ACD-TACHO

WATER BYPASS TANK



By-pass cooling tank
P/N: 90008-12ROTCOMPL

LOW LEVEL WATER CUT OUT



Water tank cut out protection
P/N: JWA220

MINE SPEC KIT (DIESEL ONLY)



Mine specification kit for diesel model only.
P/N: MINE-KIT4

EMERGENCY STOP



For more onsite safety and to meet certain site safety standards

BATTERY ISOLATOR (E-START MODELS ONLY)



For more onsite safety and to meet certain site safety standards



TURBO HEAD WITH LANCE



Complete turbo head with lance for increased cutting power.

P/N: JWA160



LS12 FOAMING KIT



LS12 Foaming lance with tank.
P/N: JWA221-LS12



GIRAFFE™ TELESCOPIC LANCE



Alloy telescopic lance (7m) to reach high places

P/N: JWA-TELE7.3

ADDITIONAL HOSE



Extra high pressure hose per metre.
P/N: 52001



HAMMERHEAD FSC 21" - ABS PLASTIC



21" Flat surface cleaner for large surface areas.

P/N: JWA-FSC21



HAMMERHEAD FSC 21" - STAINLESS STEEL



21" Stainless Steel flat surface cleaner for large surface areas.

P/N: JWA-FSC22



HAMMERHEAD FSC 30" - STAINLESS STEEL



30" Stainless Steel Flat surface cleaner for larger surface areas.

P/N: JWA-FSC30

SLUDGE KIT



Sludge kit to remove water from areas.

P/N: 80005



OEM HOSE REEL 30M



High pressure hose reel with 30m capacity.

P/N: 1060CMPL



PRO RAPID HOSE REEL 60M



High pressure hose reel with 60m capacity.

P/N: 1067CMPL



PRO RAPID STAINLESS STEEL HOSE REEL 60M



High pressure stainless steel hose reel with 60m capacity.

P/N: 1067CMLSS



SANDBLASTING KIT



Use sand to cut different material surfaces, eg stripping paint.

P/N: JWA164



PRO FOAM/TROLLEY KIT



SHOWN WITH OPTIONAL HOSE REEL

Professional foaming kit for chemical bypass cleaning.

P/N: PROFOAM
P/N: PROFOAM-TROLLEY



DRAIN CLEANING HOSE



15m of 1/8" Viperflex thermoplastic water jetting hose with nozzle.

P/N: HOP2X15VF-ASSY



DRAIN CLEANING KIT



OPTIONAL LOCKING PLATE
P/N: 90012HRH-LP

Professional remote reel with hose & professional nozzle kit.

P/N: JWA-PDCK

VULCAN V1 HOTBOX



Portable burner for hot water.

P/N: 10199

INCREASED VERSATILITY...

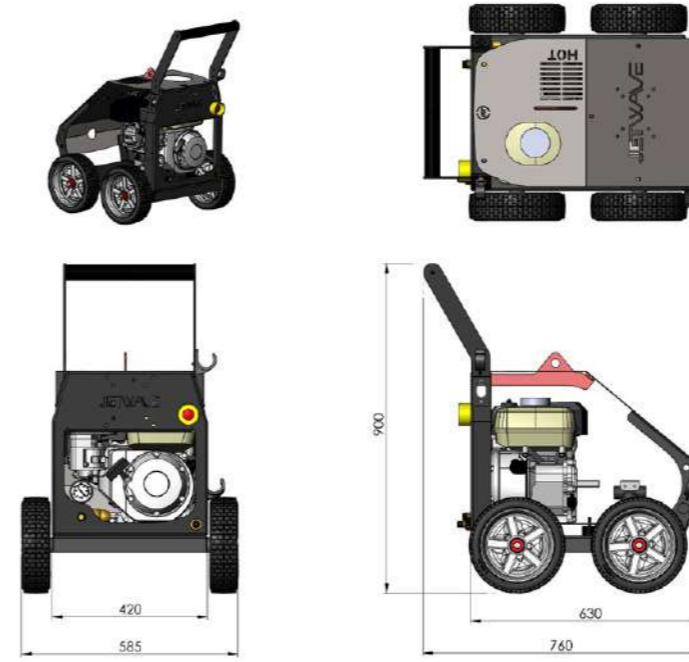
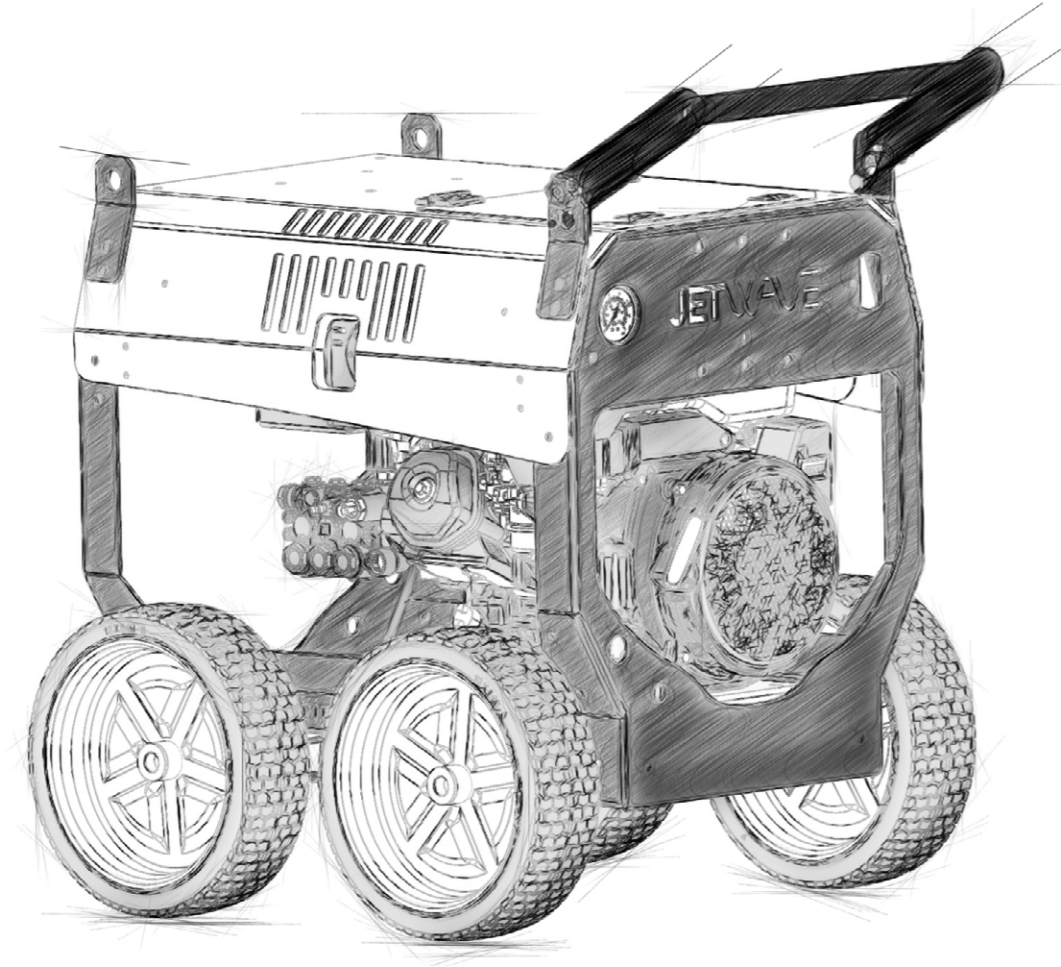

HORNET G2 JNR SKID MOUNTING DATA

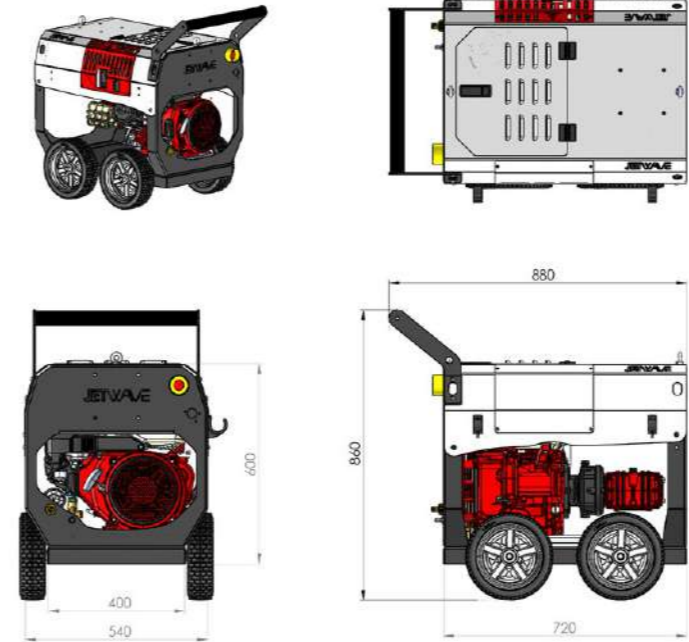
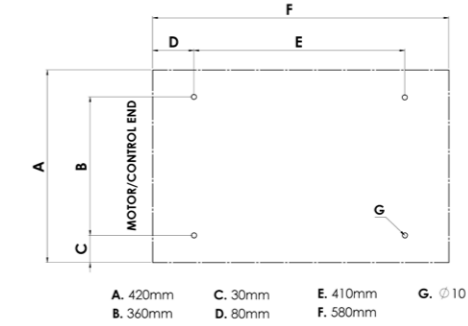

HORNET G2 SKID MOUNTING DATA

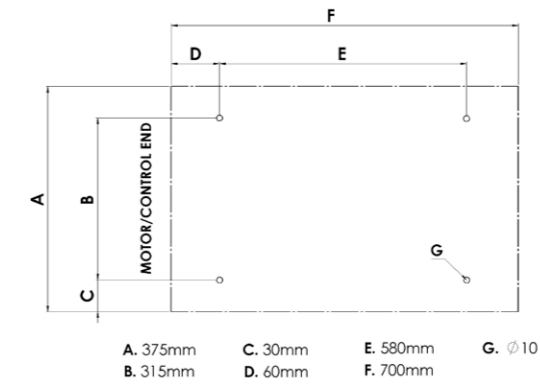

Hornet G2 represents better equipment for a better world. Our dedicated and passionate team aim to revolutionise the industry in which we operate in, therefore creating a professional value added product:

- To provide more results for your customers.
- Build job satisfaction and sustainability.
- Build your business by reducing expenses and adding to the bottom line.
- Build progress with better equipment for users contributing to a smarter, safer and more efficient world.

RANGE BUILD-UP







		HORNET G2 JNR	HORNET G2	HORNET G2 iGX	HORNET G2	HORNET G2 iGX
Product Code	p/n	CW3000-11PG2	CW4000-15PG2	CW4000-15PEIG2	CW3000-21PG2	CW3000-21PEIG2
TECHNICAL DATA						
Working Pressure	psi / bar	3150 / 210	4060 / 280	4060 / 280	3000 / 200	3000 / 200
Flow Rate	l/pm	11	15	15	21	21
Cleaning Units (CU)	psi x l/pm	34,650	54,000	54,000	63,000	63,000
Max Water Inlet Temp	°c / °f	60 / 140	60 / 140	60 / 140	60 / 140	60 / 140
INTENDED APPLICATION						
Usage Frequency	hours / type	4 - 6 Daily	4 - 6 Daily	4 - 6 Daily	4 - 6 Daily	4 - 6 daily
Class (AS/NZS: 4233)	A / B	A (1,760 BAR/LITRES)	A (4,200 BAR/LITRES)	A (4,200 BAR/LITRES)	A (4,200 BAR/LITRES)	A (4,200 BAR/LITRES)
Category of Dirt / Debris	type	Light	Medium	Medium	Medium	Medium
MOTOR FEATURES						
Engine	type	HONDA™ GX200 (4 stroke, air cooled)	HONDA™ GX390 (4 stroke, air cooled)	HONDA™ iGX390 (4 stroke, air cooled)	HONDA™ GX390 (4 stroke, air cooled)	HONDA™ iGX390 (4 stroke, air cooled)
Power	hp / cc	6.5 / 200	13 / 390	13 / 390	13 / 390	13 / 390
Fuel Supply	type	Unleaded	Unleaded	Unleaded	Unleaded	Unleaded
Fuel Capacity	litres	3.1	6.1	6.1	6.1	6.1
Low Oil Shutdown	y / n	Y	Y	Y	Y	Y
Starting System Standard	type	Recoil / Pull	Recoil / Pull	Electric Key Start	Recoil / Pull	Electric Key Start
HYDRAULIC FEATURES						
Pump / Head / Pistons	type	JW® Italian Triplex Plunger / Brass / Ceramic	JW® Italian Triplex Plunger / Brass (Nickel Plated) / Ceramic	JW® Italian Triplex Plunger / Brass (Nickel Plated) / Ceramic	JW® Italian Triplex Plunger / Brass (Nickel Plated) / Ceramic	JW® Italian Triplex Plunger / Brass (Nickel Plated) / Ceramic
Motor Pump Coupling	type	Gearbox Drive	Gearbox Drive	Gearbox Drive	Gearbox Drive	Gearbox Drive
Pump Speed	rpm	1450	1450	1450	1450	1450
Unloader Valve	type	Independent (zero)	Independent (zero)	Independent (zero)	Independent (zero)	Independent (zero)
Safety Valve	y / n	Y	Y	Y	Y	Y
Orifice / Nozzle	size	04	04	04	065	065

RANGE BUILD-UP cont.

OTHER FEATURES

Electric Key Start	y/n	N	Y	Y	N	Y
Adjustable Pressure	y/n	Y	Y	Y	Y	Y
Hose Reel Provision	y/n	Y / 2 Positions	Y / 3 Positions	Y / 3 Positions	Y / 3 Positions	Y / 3 Positions
Frame Structure	type	CNC Modular skid with heavy gauge galvanized steel chassis and stainless steel cover	CNC Modular skid with heavy gauge galvanized steel chassis and stainless steel cover	CNC Modular skid with heavy gauge galvanized steel chassis and stainless steel cover	CNC Modular skid with heavy gauge galvanized steel chassis and stainless steel cover	CNC Modular skid with heavy gauge galvanized steel chassis and stainless steel cover
Onboard Accessory Storage	y/n	Y	Y	Y	Y	Y
Detergent Injector	y/n	Y - Downstream low pressure adjustable	Y - Downstream low pressure adjustable	Y - Downstream low pressure adjustable	Y - Downstream low pressure adjustable	Y - Downstream low pressure adjustable

WARRANTY(S)

Engine Warranty	years	3		3		3		3		3	
Pump Warranty	years	2		2		2		2		2	

*Coverage against defects in material and workmanship (refer to Jetwave's and component partners T&Cs).

PACKING DETAILS

DIMENSIONS & WEIGHT

Approx Weight	kg	59 / 67 boxed	89 unit / 100 boxed	99 unit / 109 boxed	89 unit / 100 boxed	99 unit / 109 boxed
Unit Dimensions	mm	760(L) x 585(W) x 900(H)	1110(L) x 700(W) x 860(H)	1110(L) x 700(W) x 860(H)	1110(L) x 700(W) x 860(H)	1110(L) x 700(W) x 860(H)
Boxed Dimensions <small>*Add 140mm to height for pallet</small>	mm	700(L) x 600(W) x 600(H)	1000(L) x 650(W) x 950(H)	1000(L) x 650(W) x 950(H)	1000(L) x 650(W) x 950(H)	1000(L) x 650(W) x 950(H)
Number per Pallet	type: pieces	EURO: 1	EURO: 1	EURO: 1	EURO: 1	EURO: 1







The manufacturer reserves the right to modify design features and technical facts without notice, due to our principals of continuous improvement.

RANGE BUILD-UP



Product Code	p/n	CW3000-15DG2	CW4000-13DG2
--------------	-----	--------------	--------------

TECHNICAL DATA

Working Pressure	psi / bar	3150 / 210	4060 / 280
Flow Rate	l/pm	15	13
Cleaning Units (CU)	psi x l/pm	45,000	52,000
Max Water Inlet Temp	°c / °f	60 / 140	60 / 140

INTENDED APPLICATION

Usage Frequency	hours / type	4 - 6 Daily	4 - 6 daily
Class (AS/NZS: 4233)	A / B	A (3,150 BAR/LITRES)	A (3,640 BAR/LITRES)
Category of Dirt / Debris	type	Medium	Medium

MOTOR FEATURES

Engine	type	KOHLER™ KD15-440	KOHLER™ KD15-440
Power	hp / cc	10.9 / 441	10.9 / 441
Fuel Supply	type	Diesel	Diesel
Fuel Capacity	litres	4.3	4.3
Low Oil Shutdown	y / n	Y	Y
Starting System Standard	type	Electric Key Start	Electric Key Start

HYDRAULIC FEATURES

Pump / Head / Pistons	type	JW® Italian Triplex Plunger / Brass (Nickel Plated) / Ceramic	JW® Italian Triplex Plunger / Brass / Ceramic
Motor Pump Coupling	type	Gearbox Drive	Gearbox Drive
Pump Speed	rpm	1450	1450
Unloader Valve	type	Independent (zero)	Independent (zero)
Safety Valve	y / n	Y	Y
Orifice / Nozzle	size	045	035

RANGE BUILD-UP cont.

OTHER FEATURES

Electric / Key Start Available	y/n	Y - Standard	Y - Standard
Adjustable Pressure	y / n	Y	Y
Hose Reel Provision	y / n	Y / 3 Positions	Y / 3 Positions
Frame Structure	type	CNC Modular skid with heavy gauge galvanized steel chassis and stainless steel cover	CNC Modular skid with heavy gauge galvanized steel chassis and stainless steel cover
Onboard Accessory Storage	y / n	Y	Y
Detergent Injector	y / n	Y - Downstream low pressure adjustable	Y - Downstream low pressure adjustable

WARRANTY(S)

Engine Warranty	years	3 KOHLER Diesel	3 KOHLER Diesel
Pump Warranty	years	2	2

*Coverage against defects in material and workmanship (refer to Jetwave's and component partners T&Cs).

PACKING DETAILS

DIMENSIONS & WEIGHT

Approx Weight	kg	115 unit / 125 boxed	115 unit / 125 boxed
Unit Dimensions	mm	1110(L) x 700(W) x 860(H)	1110(L) x 700(W) x 860(H)
Boxed Dimensions <small>*Add 140mm to height for pallet</small>	mm	1000(L) x 650(W) x 950(H)	1000(L) x 650(W) x 950(H)

Number per Pallet	type: pieces	EURO: 1	EURO: 1
-------------------	--------------	---------	---------

The manufacturer reserves the right to modify design features and technical facts without notice, due to our principals of continuous improvement.



V2.3 06/2022

Jetwave® and Hornet G2™ are registered trademarks of Jetwave® Group Pty Ltd.

Distributed by:



SEWER CAMERAS AUSTRALIA
1300 660 358

For more information on our products, please visit jetwavegroup.com